



SERIES 500 SWITCHES

SLIDE SWITCHES

TACT SWITCHES

NAVIGATION SWITCHES

PUSHBUTTON SWITCHES

TOGGLE SWITCHES

ROCKER SWITCHES

SLIDE SWITCHES

SNAP-ACTION SWITCHES

DIP SWITCHES

KEYLOCK SWITCHES

ROTARY SWITCHES

DETECTOR SWITCHES

CAP OPTIONS

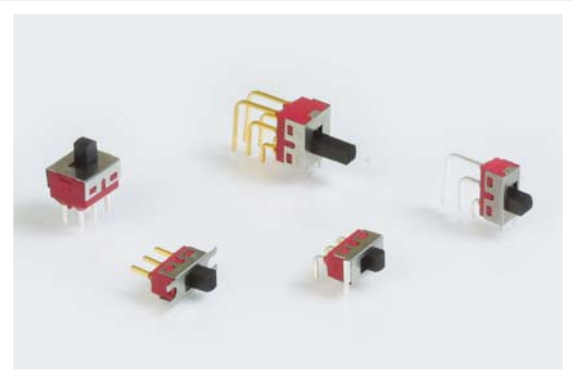

SPECIFICATIONS

Contact Rating:	Gold, 0.4 VA @ 20 VAC or DC Silver, 5A @ 120 VAC, 2A @ 250 VAC
Life Expectancy:	50,000 make-and-break cycles at full load
Contact Resistance:	10 mΩ max. typical @ 2-4 VDC 100mA for both silver and gold plated contacts
Insulation Resistance:	1,000 MΩ min.
Dielectric Strength:	1,000 V rms at sea level
Operating Temperature:	-30°C to 85°C

FEATURES & BENEFITS

- ▶ Single & double pole options
- ▶ Multiple actuator height options
- ▶ Panel & PC board mountable

APPLICATIONS/MARKETS

- ▶ Computer servers/peripherals
- ▶ Consumer electronics
- ▶ Instrumentation
- ▶ Test & measurement

MATERIALS

Case:	Diallyl phthalate (DAP), UL 94V0
Housing:	Stainless steel
Slide Handle:	Nylon UL 94HB
Contacts:	Silver or gold plated copper alloy

HOW TO ORDER

SERIES	MODEL NO.	ACTUATOR	TERMINATION	CONTACT MATERIAL	SEAL	MOUNTING TAB
500	SSP1 SSP2 SSP3	S1 S2 S3 S4	M1 M2 M3 M5-1 M5-2 M5-3 M5-4 M6 M7 VS2	Q = Silver R = Gold	E = Epoxy Sealed	A = Without Tabs B = With Tabs

▶ ▶ ▶ **Example Ordering Number**
500-SSP2-S4-M1-Q-E-B

SDP1 SDP3	S1 S2 S3 S4 S5	M1 M2 M3 M5-1 M5-2 M5-3 M5-4 M6 M7 VS2	Q = Silver R = Gold	E = Epoxy Sealed	A = Without Tabs B = With Tabs
--------------	----------------------------	---	------------------------	------------------	-----------------------------------

▶ ▶ ▶ **Example Ordering Number**
500-SDP1-S1-M6-R-E-A

Specifications subject to change without notice.



SPDT



2 Comm.
1 3

SCHEMATIC

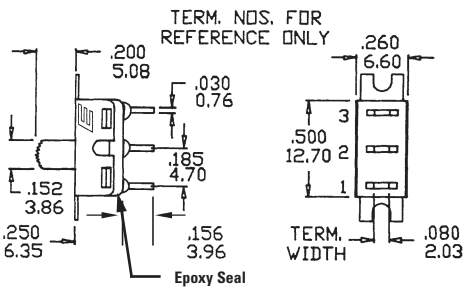
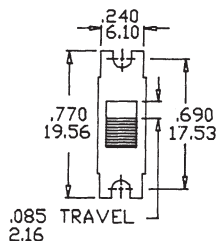

Model No.	POS 1	POS 2	POS 3
SSP-1	ON	NONE	ON
SSP-2	ON	NONE	(ON)
SSP-3	ON	OFF	ON
Term. Comm.	2-1	OPEN	2-3

() = Momentary

DPDT



2 Comm. 5 Comm.
1 3 4 6

SCHEMATIC

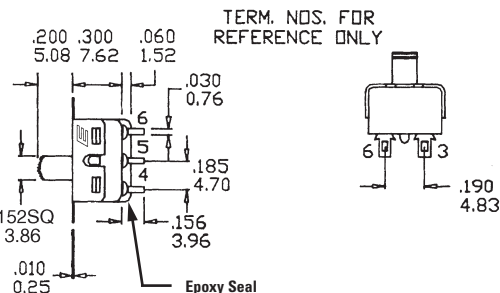
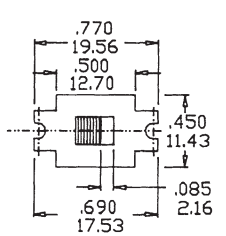

Model No.	POS 1	POS 2	POS 3
SDP-1	ON	NONE	ON
SDP-3	ON	OFF	ON
Term. Comm.	2-1, 5-4	OPEN	2-3, 5-6

ACTUATOR OPTIONS

S1 STD†

† Standard for all DPDT versions.

S2

S3

S4

S5

* Subtract 0.012 (0.301) from actuator height for M6, M7 PC mounting options.

TERMINATION OPTIONS

M1 SOLDER LUG

0.030 (0.76) THK

M2 P.C. MOUNT

0.030 (0.76) THK

M3 QUICK CONNECT

0.030 (0.76) THK
MATING QUICK CONNECTOR
AMP P/N 60900-1

M5 WIRE WRAP

Option Code	Dim. 'A'
M51	.736 (18.70)
M52	.953 (24.20)
M53	.415 (10.55)
M54	1.062 (26.97)



SERIES 500 SWITCHES

SLIDE SWITCHES

TACT SWITCHES

NAVIGATION SWITCHES

PUSHBUTTON SWITCHES

TOGGLE SWITCHES

ROCKER SWITCHES

SLIDE SWITCHES

SNAP-ACTION SWITCHES

DIP SWITCHES

KEYLOCK SWITCHES

ROTARY SWITCHES

DETECTOR SWITCHES

CAP OPTIONS

M6

SPDT

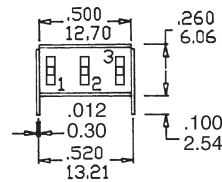
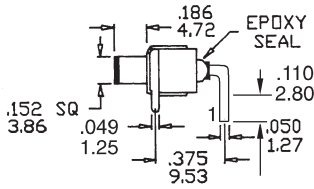
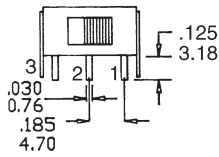

TERM. NOS. FOR REFERENCE ONLY

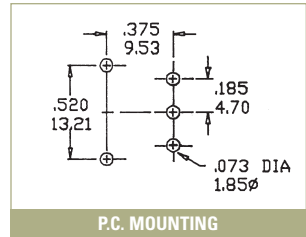

P.C. MOUNTING

M6

DPDT

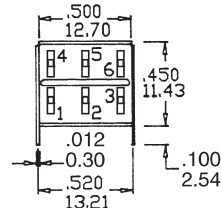
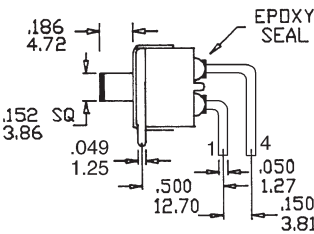
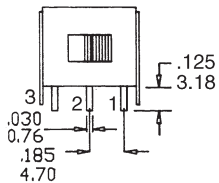

TERM. NOS. FOR REFERENCE ONLY

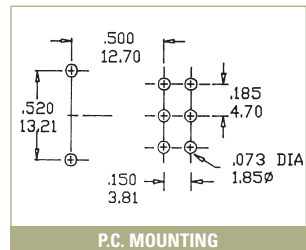

P.C. MOUNTING

M7

SPDT

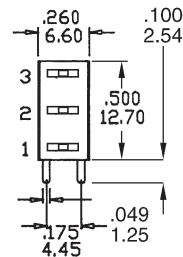
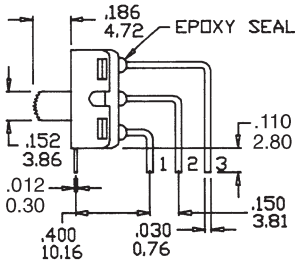
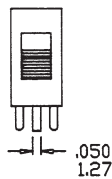

TERM. NOS. FOR REFERENCE ONLY

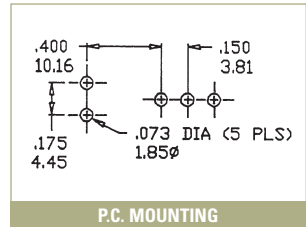

P.C. MOUNTING

M7

DPDT

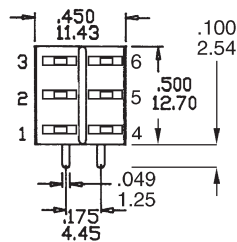
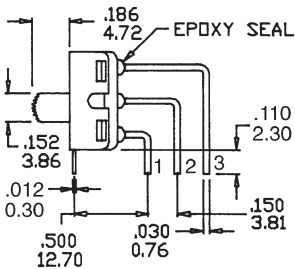
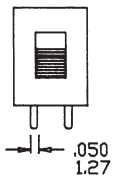

TERM. NOS. FOR REFERENCE ONLY

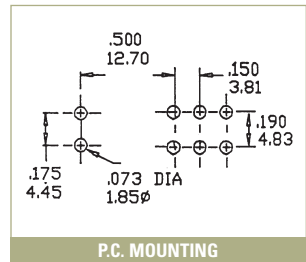

P.C. MOUNTING

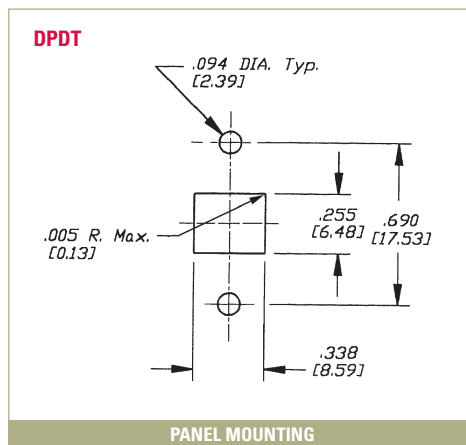
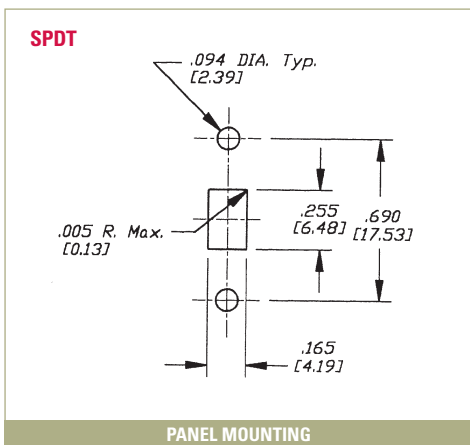

MOUNTING TABS

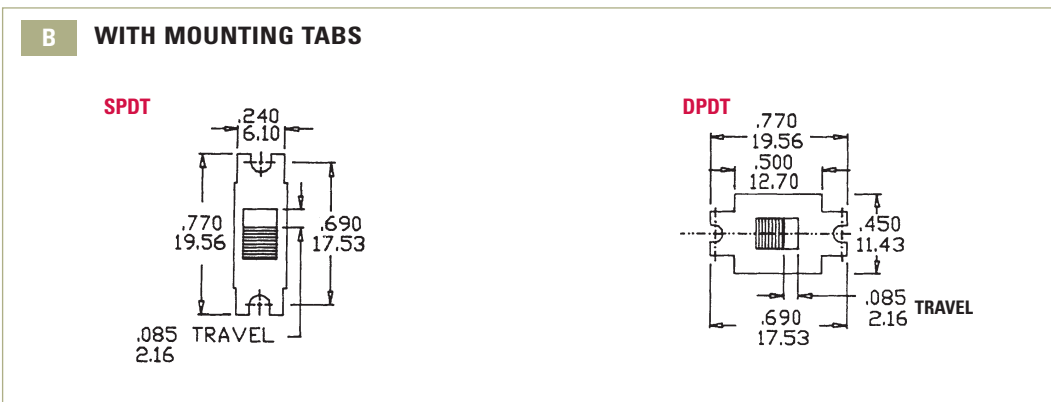
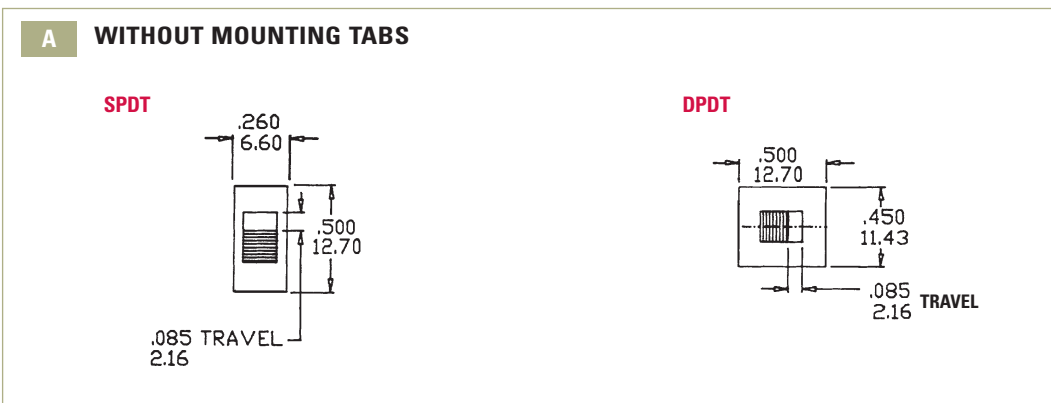

CONTACT MATERIAL OPTIONS

Q

Fixed Terminal:	Silver plated copper alloy
Moving Contact:	Silver plated copper alloy
Rating:	5 Amps with resistive load @ 120VAC or 28VDC 2 Amps with resistive load @ 250VAC

R

Fixed Terminal:	Copper alloy with gold plate over nickel plate
Moving Contact:	Copper alloy with gold plate over nickel plate
Rating:	0.4 Volt-Amps (VA) max. @ 20V max. (AC or DC)

TACT SWITCHES
 NAVIGATION SWITCHES
 PUSHBUTTON SWITCHES
 TOGGLE SWITCHES
 ROCKER SWITCHES
 SLIDE SWITCHES
 SNAP-ACTION SWITCHES
 DIP SWITCHES
 KEYLOCK SWITCHES
 ROTARY SWITCHES
 DETECTOR SWITCHES
 CAP OPTIONS



ООО «НИОКРсистемс» - это оперативные поставки широкого спектра электронных компонентов отечественного и импортного производства напрямую от производителей и с крупнейших мировых складов. Реализуемая нашей компанией продукция насчитывает более полумиллиона наименований.

Благодаря этому наша компания предлагает к поставке практически не ограниченный ассортимент компонентов как оптовыми, мелкооптовыми партиями, так и в розницу.

Благодаря развитой сети поставщиков, помогаем в поиске и приобретении экзотичных или снятых с производства компонентов.

Наша компания это:

- Гарантия качества поставляемой продукции
- Широкий ассортимент
- Минимальные сроки поставок
- Техническая поддержка
- Подбор комплектации
- Индивидуальный подход
- Гибкое ценообразование
- Работаем по 275 ФЗ