

FDS9936A Dual N-Channel Enhancement Mode Field Effect Transistor

General Description

SO-8 N-Channel enhancement mode power field effect transistors are produced using Fairchild's proprietary, high cell density, DMOS technology. This very high density process is especially tailored to provide superior switching performance and minimize on-state resistance. These devices are particularly suited for low voltage applications such as disk drive motor control, battery powered circuits where fast switching, low in-line power loss, and resistance to transients are needed.

Features

- 5.5 A, 30 V. $R_{DS(ON)} = 0.040 \Omega @ V_{GS} = 10 \text{ V}$,
 $R_{DS(ON)} = 0.060 \Omega @ V_{GS} = 4.5 \text{ V}$.
- High density cell design for extremely low $R_{DS(ON)}$.
- High power and current handling capability in a widely used surface mount package.
- Dual MOSFET in surface mount package

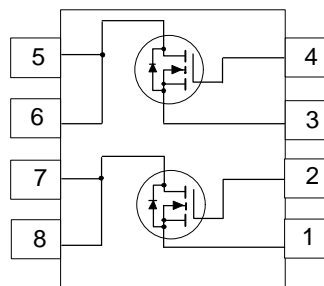
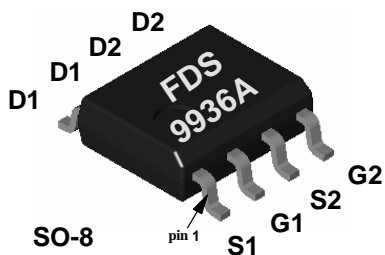
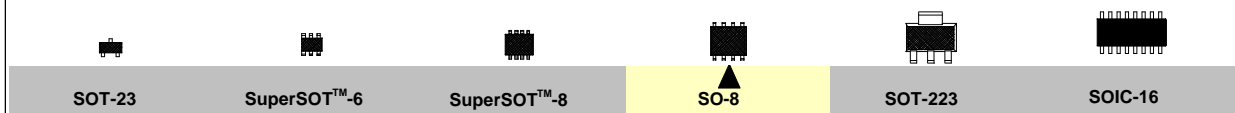

Absolute Maximum Ratings $T_A = 25^\circ\text{C}$ unless otherwise noted

| Symbol | Parameter | FDS9936A | Units |
|----------------|--|------------|------------------|
| V_{DSS} | Drain-Source Voltage | 30 | V |
| V_{GSS} | Gate-Source Voltage | ± 20 | V |
| I_D | Drain Current - Continuous (Note 1a) | 5.5 | A |
| | - Pulsed | 20 | |
| P_D | Power Dissipation for Dual Operation | 2 | W |
| | Power Dissipation for Single Operation (Note 1a) | 1.6 | |
| | (Note 1b) | 1 | |
| | (Note 1c) | 0.9 | |
| T_J, T_{STG} | Operating and Storage Temperature Range | -55 to 150 | $^\circ\text{C}$ |

THERMAL CHARACTERISTICS

| | | | |
|-----------------|---|----|--------------------|
| $R_{\theta JA}$ | Thermal Resistance, Junction-to-Ambient (Note 1a) | 78 | $^\circ\text{C/W}$ |
| $R_{\theta JC}$ | Thermal Resistance, Junction-to-Case (Note 1) | 40 | $^\circ\text{C/W}$ |

Electrical Characteristics (T_A = 25 °C unless otherwise noted)

| Symbol | Parameter | Conditions | Min | Typ | Max | Units |
|---|---|--|-----|-------|-------|-------|
| OFF CHARACTERISTICS | | | | | | |
| BV _{DSS} | Drain-Source Breakdown Voltage | V _{GS} = 0 V, I _D = 250 μA | 30 | | | V |
| ΔBV _{DSS} /ΔT _J | Breakdown Voltage Temp. Coefficient | I _D = 250 μA, Referenced to 25 °C | | 32 | | mV/°C |
| I _{DSS} | Zero Gate Voltage Drain Current | V _{DS} = 24 V, V _{GS} = 0 V T _J = 55°C | | | 1 | μA |
| | | | | | 10 | μA |
| I _{GSSF} | Gate - Body Leakage, Forward | V _{GS} = 20 V, V _{DS} = 0 V | | | 100 | nA |
| I _{GSSR} | Gate - Body Leakage, Reverse | V _{GS} = -20 V, V _{DS} = 0 V | | | -100 | nA |
| ON CHARACTERISTICS (Note 2) | | | | | | |
| V _{GS(th)} | Gate Threshold Voltage | V _{DS} = V _{GS} , I _D = 250 μA | 1 | 1.5 | 3 | V |
| ΔV _{GS(th)} /ΔT _J | Gate Threshold Voltage Temp. Coefficient | I _D = 250 μA, Referenced to 25 °C | | -4.3 | | mV/°C |
| R _{DS(on)} | Static Drain-Source On-Resistance | V _{GS} = 10 V, I _D = 5.5 A T _J = 125°C | | 0.03 | 0.04 | Ω |
| | | | | | 0.046 | |
| | | V _{GS} = 4.5 V, I _D = 4.5 A | | 0.045 | 0.06 | |
| I _{D(on)} | On-State Drain Current | V _{GS} = 10 V, V _{DS} = 5 V | 20 | | | A |
| g _{FS} | Forward Transconductance | V _{DS} = 5 V, I _D = 4.7 A | | 7 | | S |
| DYNAMIC CHARACTERISTICS | | | | | | |
| C _{iss} | Input Capacitance | V _{DS} = 15 V, V _{GS} = 0 V, f = 1.0 MHz | | 350 | | pF |
| C _{oss} | Output Capacitance | | | 220 | | pF |
| C _{rss} | Reverse Transfer Capacitance | | | 80 | | pF |
| SWITCHING CHARACTERISTICS (Note 2) | | | | | | |
| t _{D(on)} | Turn - On Delay Time | V _{DD} = 10 V, I _D = 1 A, V _{GS} = 4.5 V, R _{GEN} = 6 Ω | | 7.5 | 15 | ns |
| t _r | Turn - On Rise Time | | | 12 | 25 | |
| t _{D(off)} | Turn - Off Delay Time | | | 13 | 25 | |
| t _f | Turn - Off Fall Time | | | 6 | 15 | |
| Q _g | Total Gate Charge | V _{DS} = 15 V, I _D = 5 A, V _{GS} = 10 V | | 12 | 17 | nC |
| Q _{gs} | Gate-Source Charge | | | 2.1 | | |
| Q _{gd} | Gate-Drain Charge | | | 2.6 | | |
| DRAIN-SOURCE DIODE CHARACTERISTICS AND MAXIMUM RATINGS | | | | | | |
| I _S | Maximum Continuous Drain-Source Diode Forward Current | | | | 1.3 | A |
| V _{SD} | Drain-Source Diode Forward Voltage | V _{GS} = 0 V, I _S = 1.3 A (Note 2) | | 0.76 | 1.2 | V |

Notes:

- R_{θJA} is the sum of the junction-to-case and case-to-ambient thermal resistance where the case thermal reference is defined as the solder mounting surface of the drain pins. R_{θJC} is guaranteed by design while R_{θCA} is determined by the user's board design.

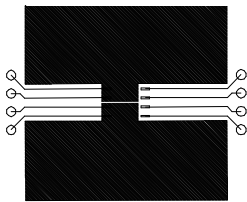

a. 78°C/W on a 0.5 in² pad of 2oz copper.

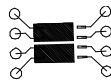

b. 125°C/W on a 0.02 in² pad of 2oz copper.

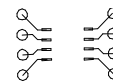

c. 135°C/W on a 0.003 in² pad of 2oz copper.

- Scale 1 : 1 on letter size paper
2. Pulse Test: Pulse Width ≤ 300μs, Duty Cycle ≤ 2.0%.

Typical Electrical Characteristics

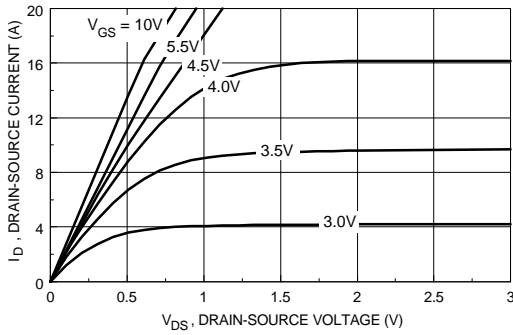

Figure 1. On-Region Characteristics.

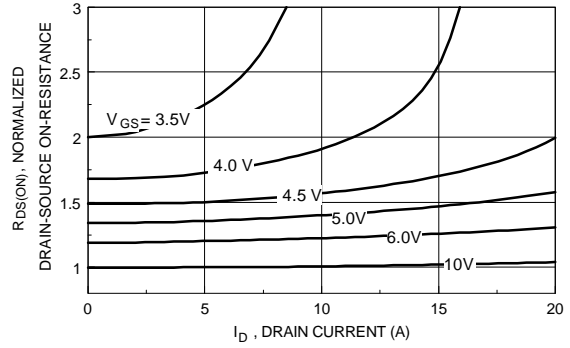

Figure 2. On-Resistance Variation with Drain Current and Gate Voltage.

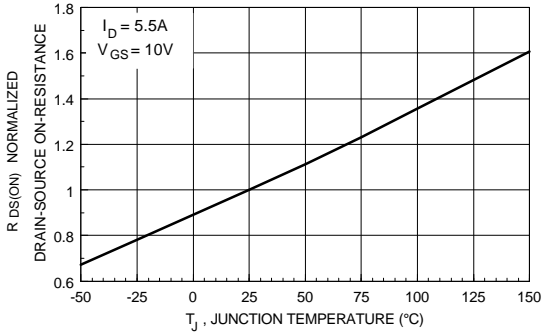

Figure 3. On-Resistance Variation with Temperature.

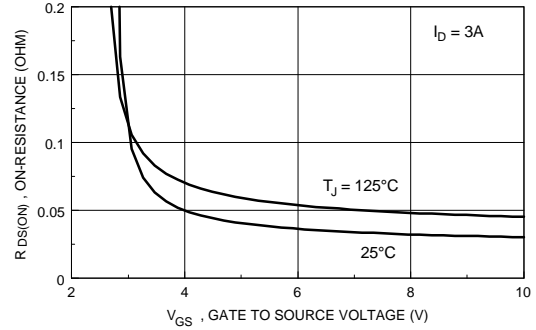

Figure 4. On-Resistance Variation with Gate-to-Source Voltage.

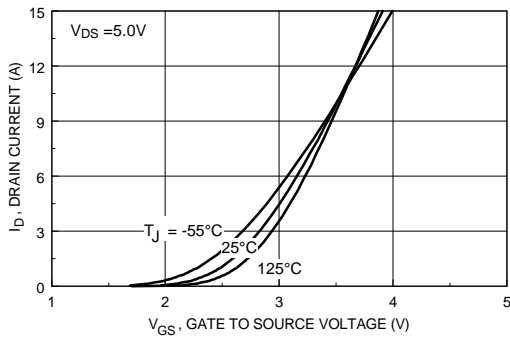

Figure 5. Transfer Characteristics.

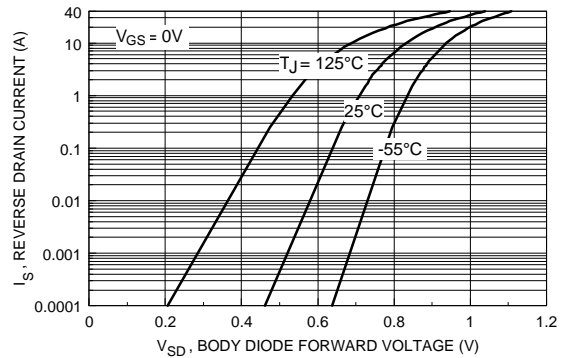

Figure 6 . Body Diode Forward Voltage Variation with Source Current and Temperature.

Typical Electrical Characteristics (continued)

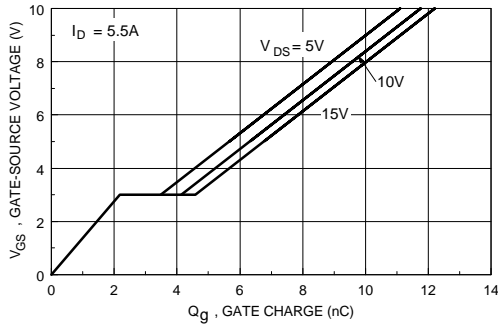

Figure 7. Gate Charge Characteristics.

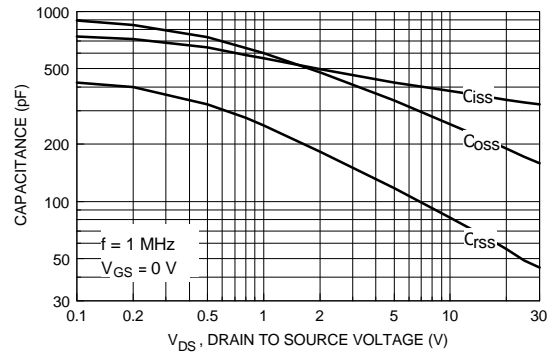

Figure 8. Capacitance Characteristics.

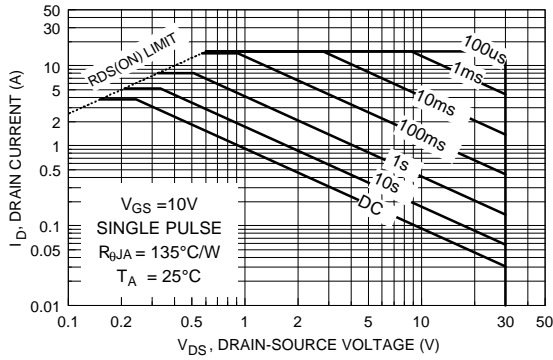

Figure 9. Maximum Safe Operating Area.

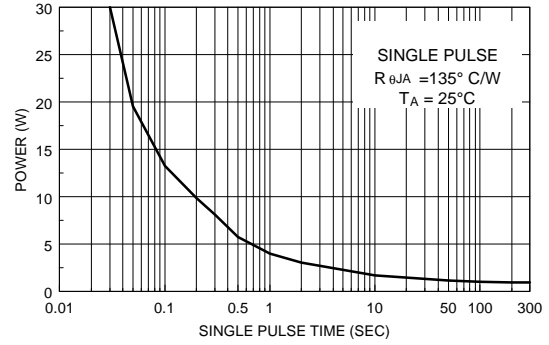

Figure 10. Single Pulse Maximum Power Dissipation.

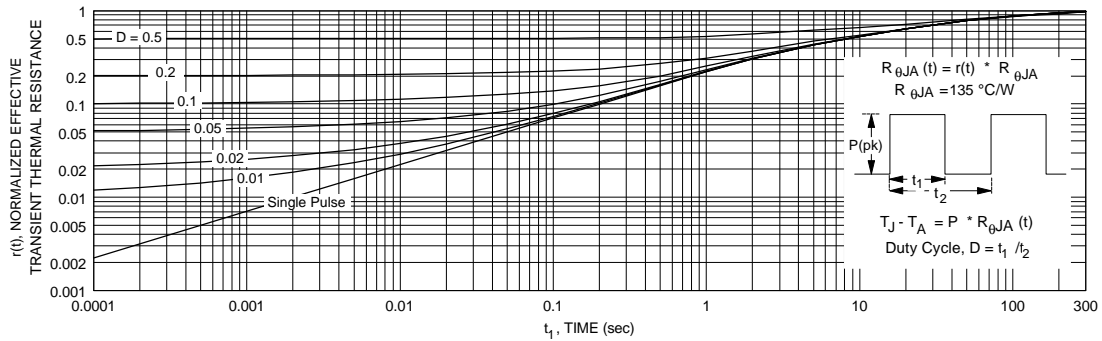

Figure 11. Transient Thermal Response Curve.

Thermal characterization performed using the conditions described in Note 1c.
Transient thermal response will change depending on the circuit board design.

SO-8 Tape and Reel Data and Package Dimensions



SOIC(8lds) Packaging Configuration: Figure 1.0



Packaging Description:

SOIC-8 parts are shipped in tape. The carrier tape is made from a dissipative (carbon filled) polycarbonate resin. The cover tape is a multilayer film (Heat Activated Adhesive in nature) primarily composed of polyester film, adhesive layer, sealant, and anti-static sprayed agent. These reeled parts in standard option are shipped with 2,500 units per 13" or 330cm diameter reel. The reels are dark blue in color and is made of polystyrene plastic (anti-static coated). Other option comes in 500 units per 7" or 177cm diameter reel. This and some other options are further described in the Packaging Information table.

These full reels are individually barcode labeled and placed inside a standard intermediate box (illustrated in figure 1.0) made of recyclable corrugated brown paper. One box contains two reels maximum. And these boxes are placed inside a barcode labeled shipping box which comes in different sizes depending on the number of parts shipped.



SOIC-8 Unit Orientation

| SOIC (8lds) Packaging Information | | | | |
|-----------------------------------|-------------------------|------------|------------|------------|
| Packaging Option | Standard (no flow code) | L86Z | F011 | D84Z |
| Packaging type | TNR | Rail/Tube | TNR | TNR |
| Qty per Reel/Tube/Bag | 2,500 | 95 | 4,000 | 500 |
| Reel Size | 13" Dia | - | 13" Dia | 7" Dia |
| Box Dimension (mm) | 343x64x343 | 530x130x83 | 343x64x343 | 184x187x47 |
| Max qty per Box | 5,000 | 30,000 | 8,000 | 1,000 |
| Weight per unit (gm) | 0.0774 | 0.0774 | 0.0774 | 0.0774 |
| Weight per Reel (kg) | 0.6060 | - | 0.9696 | 0.1182 |
| Note/Comments | | | | |

F63TNR Label sample



SOIC(8lds) Tape Leader and Trailer Configuration: Figure 2.0



SO-8 Tape and Reel Data and Package Dimensions, continued

SOIC(8lds) Embossed Carrier Tape Configuration: Figure 3.0



| Dimensions are in millimeter | | | | | | | | | | | | | | |
|------------------------------|-----------------|-----------------|----------------|-----------------|-----------------|-----------------|--------------|-----------------|---------------|---------------|----------------|-----------------------|---------------|-----------------|
| Pkg type | A0 | B0 | W | D0 | D1 | E1 | E2 | F | P1 | P0 | K0 | T | Wc | Tc |
| SOIC(8lds) (12mm) | 6.50 +/-0.10 | 5.30 +/-0.10 | 12.0 +/-0.3 | 1.55 +/-0.05 | 1.60 +/-0.10 | 1.75 +/-0.10 | 10.25 min | 5.50 +/-0.05 | 8.0 +/-0.1 | 4.0 +/-0.1 | 2.1 +/-0.10 | 0.450 +/- 0.150 | 9.2 +/-0.3 | 0.06 +/-0.02 |

Notes: A0, B0, and K0 dimensions are determined with respect to the EIA/Jedec RS-481 rotational and lateral movement requirements (see sketches A, B, and C).

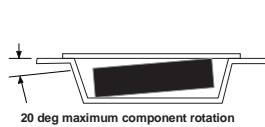

Sketch A (Side or Front Sectional View)
Component Rotation

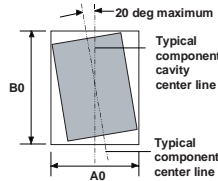

Sketch B (Top View)
Component Rotation

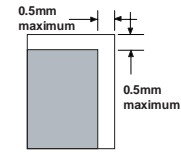

Sketch C (Top View)
Component lateral movement

SOIC(8lds) Reel Configuration: Figure 4.0

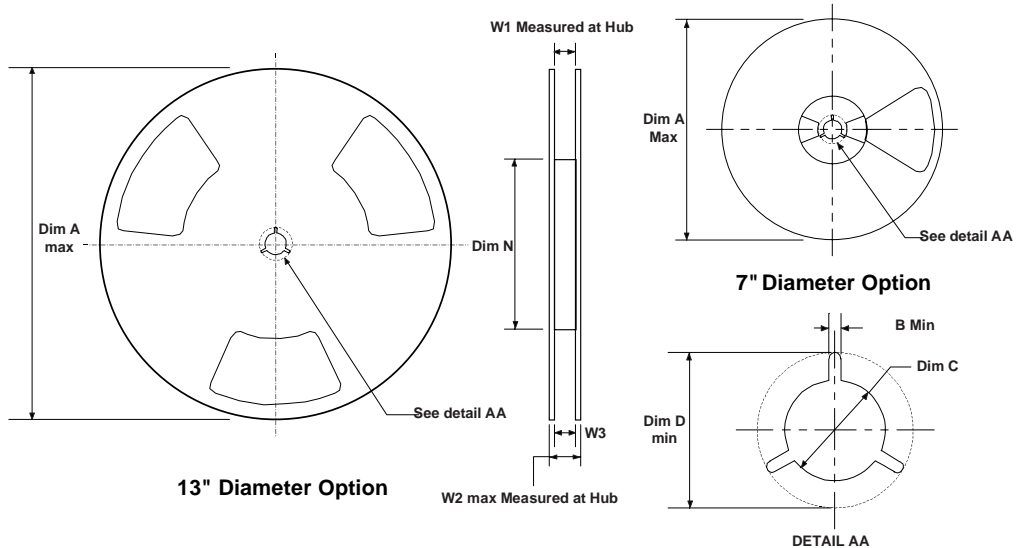

| Dimensions are in inches and millimeters | | | | | | | | | |
|--|-------------|---------------|--------------|-----------------------------------|---------------|-------------|----------------------------------|---------------|------------------------------|
| Tape Size | Reel Option | Dim A | Dim B | Dim C | Dim D | Dim N | Dim W1 | Dim W2 | Dim W3 (LSL-USL) |
| 12mm | 7" Dia | 7.00 177.8 | 0.059 1.5 | 512 +0.020/-0.008 13 +0.5/-0.2 | 0.795 20.2 | 2.165 55 | 0.488 +0.078/-0.000 12.4 +2/0 | 0.724 18.4 | 0.469 - 0.606 11.9 - 15.4 |
| 12mm | 13" Dia | 13.00 330 | 0.059 1.5 | 512 +0.020/-0.008 13 +0.5/-0.2 | 0.795 20.2 | 7.00 178 | 0.488 +0.078/-0.000 12.4 +2/0 | 0.724 18.4 | 0.469 - 0.606 11.9 - 15.4 |

SO-8 Tape and Reel Data and Package Dimensions, continued

SOIC-8 (FS PKG Code S1)



Scale 1:1 on letter size paper

Dimensions shown below are in:
inches [millimeters]

Part Weight per unit (gram): 0.0774



NOTES : UNLESS OTHERWISE SPECIFIED

- STANDARD LEAD FINISH:
200 MICROINCHES / 5.08 MICRONS MINIMUM
LEAD / TIN (SOLDER) ON COPPER.

SO 0.150 WIDE 8 LEADS

- THESE DIMENSIONS DO NOT INCLUDE MOLD FLASH
- MAXIMUM LEAD 0.024 [0.609]

TRADEMARKS

The following are registered and unregistered trademarks Fairchild Semiconductor owns or is authorized to use and is not intended to be an exhaustive list of all such trademarks.

| | | |
|----------------------|---------------|------------|
| ACEx™ | ISOPANAR™ | TinyLogic™ |
| CoolFET™ | MICROWIRE™ | UHC™ |
| CROSSVOLT™ | POP™ | VCX™ |
| E ² CMOS™ | PowerTrench™ | |
| FACT™ | QFET™ | |
| FACT Quiet Series™ | QS™ | |
| FAST® | Quiet Series™ | |
| FASTr™ | SuperSOT™-3 | |
| GTO™ | SuperSOT™-6 | |
| HiSeC™ | SuperSOT™-8 | |

DISCLAIMER

FAIRCHILD SEMICONDUCTOR RESERVES THE RIGHT TO MAKE CHANGES WITHOUT FURTHER NOTICE TO ANY PRODUCTS HEREIN TO IMPROVE RELIABILITY, FUNCTION OR DESIGN. FAIRCHILD DOES NOT ASSUME ANY LIABILITY ARISING OUT OF THE APPLICATION OR USE OF ANY PRODUCT OR CIRCUIT DESCRIBED HEREIN; NEITHER DOES IT CONVEY ANY LICENSE UNDER ITS PATENT RIGHTS, NOR THE RIGHTS OF OTHERS.

LIFE SUPPORT POLICY

FAIRCHILD'S PRODUCTS ARE NOT AUTHORIZED FOR USE AS CRITICAL COMPONENTS IN LIFE SUPPORT DEVICES OR SYSTEMS WITHOUT THE EXPRESS WRITTEN APPROVAL OF FAIRCHILD SEMICONDUCTOR CORPORATION. As used herein:

1. Life support devices or systems are devices or systems which, (a) are intended for surgical implant into the body, or (b) support or sustain life, or (c) whose failure to perform when properly used in accordance with instructions for use provided in the labeling, can be reasonably expected to result in significant injury to the user.
2. A critical component is any component of a life support device or system whose failure to perform can be reasonably expected to cause the failure of the life support device or system, or to affect its safety or effectiveness.

PRODUCT STATUS DEFINITIONS

Definition of Terms

| Datasheet Identification | Product Status | Definition |
|--------------------------|------------------------|---|
| Advance Information | Formative or In Design | This datasheet contains the design specifications for product development. Specifications may change in any manner without notice. |
| Preliminary | First Production | This datasheet contains preliminary data, and supplementary data will be published at a later date. Fairchild Semiconductor reserves the right to make changes at any time without notice in order to improve design. |
| No Identification Needed | Full Production | This datasheet contains final specifications. Fairchild Semiconductor reserves the right to make changes at any time without notice in order to improve design. |
| Obsolete | Not In Production | This datasheet contains specifications on a product that has been discontinued by Fairchild semiconductor. The datasheet is printed for reference information only. |



ООО «НИОКРсистемс» - это оперативные поставки широкого спектра электронных компонентов отечественного и импортного производства напрямую от производителей и с крупнейших мировых складов. Реализуемая нашей компанией продукция насчитывает более полумиллиона наименований.

Благодаря этому наша компания предлагает к поставке практически не ограниченный ассортимент компонентов как оптовыми, мелкооптовыми партиями, так и в розницу.

Благодаря развитой сети поставщиков, помогаем в поиске и приобретении экзотичных или снятых с производства компонентов.

Наша компания это:

- Гарантия качества поставляемой продукции
- Широкий ассортимент
- Минимальные сроки поставок
- Техническая поддержка
- Подбор комплектации
- Индивидуальный подход
- Гибкое ценообразование
- Работаем по 275 ФЗ